



# MOCEAN<sup>®</sup>

"FENDING", INNOVATION AND EXCELLENCE

## 2016





**“FENDING”, INNOVATION AND EXCELLENCE**

*Since 1985 we are the first in the world to design and produce a range of solid boat fenders, bow and stern fenders made in integral polyurethane.*

**In 2013 we set new standards in the fender market.**

Continuing our 30 years of history in introducing and producing unique and high technology fenders, we have presented a brand new range, the **“OCEAN classic fenders”**.

Being regarded as the most innovative brand in the fenders market, we shall continue to manufacture...

**THE BEST FENDERS** in the market.

**In 2015 we are presenting new mega yacht fenders of supreme quality, MAGNUS & EASYSTORE PLUS**

Welcome to a world surrounded by OCEAN

**Maximum  
Protection**

**Life  
Performance**

**Consistency**

**Supreme Quality**

**Exclusive Design**



## OCEAN Classic Fenders & Fender Covers



4 SERIES H

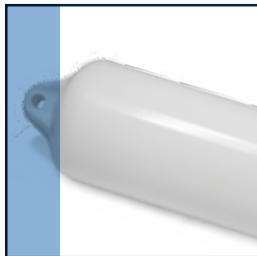

5 SERIES L



6 SERIES RT

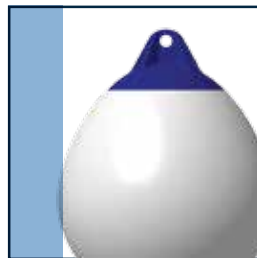

7 SERIES R



6 for SERIES H-L-RT



7 SERIES R

## OCEAN Inflatable Fenders



8 EASYSTORE PLUS



9 MAGNUS

## OCEAN Dock Fenders

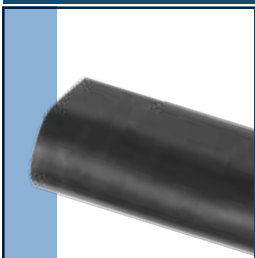

15 DOCK

## OCEAN Solid Fenders & Fender Covers



10 SOLOVELA



10 for SOLOVELA

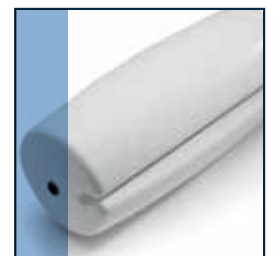

11 TYPE A



12 PVM1



13 PVM2

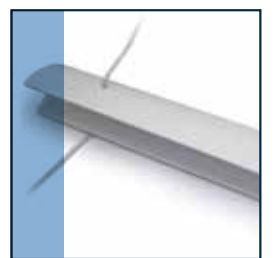

13 BLADE



14 MATCH 60

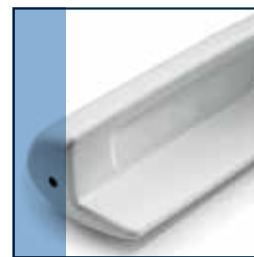

14 MATCH 80

## OCEAN Sail Accessories



15 LIFEBUOY SUPPORT



15 SAIL DEFENDER



16 STANCHION



16 ALVEA



17 CAN HOLDER

# THE BEST FENDERS FOR YOUR BOAT



## CHOOSE THE FENDER YOUR BOAT NEEDS

BOAT LENGTH (ft/m)

SERIES	10' / 3m	20' / 6m	30' / 9m	40' / 12m	50' / 15m	60' / 18m	70' / 21m
	L1	←→					
	L2/H2	←→					
	L3/H3		←→				
	L4/H4		←→				
	L5/H5		←→				
	L6/H6			←→			
	H7		←→				
	H8			←→			
	H9			←→			
	H10				←→		
	RT1	←→					
	RT2		←→				
	RT3			←→			
	R0	←→					
	R1		←→				
	R2			←→			
	R3			←→			
	R4				←→		
	R5				←→		
	R6					←→	
	R7						←→
	A1	←→					
	A2		←→				
	A3			←→			
	A4				←→		
	SOLOVELA	←→					

# CHOOSE THE FENDER YOUR MEGA YACHT NEEDS

BOAT LENGTH (ft/m)

SERIES		30' / 9m	40' / 12m	50' / 15m	70' / 21m	130' / 40m	160' / 50m	210' / 66m
 <b>EASYSTORE PLUS</b>	57327	←→						
	57328		←→					
	57316			←→				
	57317				←→			
	57318					←→		
 <b>MAGNUS</b>	72159					←→		
	72162					←→		
	72160						←→	
	72161							←→
	72163							←→

## WARRANTY

### OCEAN LIMITED WARRANTY

#### WHAT THIS WARRANTY COVERS

OCEAN warrants its products to be free of defects in workmanship and material under normal use and service and when used for the purposes and under the conditions for which they are intended.

#### WHAT THIS WARRANTY DOES NOT COVER

This warranty does not apply to any problem caused by:

- 1) unusual conditions such as severe storms, hurricanes, extreme temperatures, UV light breakdown, or ultraviolet rays. Also, the warranty does not cover cosmetic flaws that result from normal wear and tear under ordinary use and do not affect the performance or use of the product.
- 2) intentional damage by people
- 3) cuts, punctures, or exposures to chemicals that degrade or discolor plastics
- 5) abuse, neglect, accident, misuse, alteration, unauthorized repair, improper handling, or improper use
- 4) improper inflation of any product, including under or over inflation (please refer to inflation guide for maximum inflation values)

Because it is impossible for OCEAN to know the exact purposes for which you acquired the OCEAN product or the uses to which you will put the product, OCEAN shall not be responsible for the selection of the product for its installation and use. While every reasonable effort has been made to insure that you will receive a product that you can use and enjoy, OCEAN does not warrant that the product will meet your requirements.

NO WORDS, ACTIONS, DESCRIPTIONS, MODELS, SAMPLES  
OR OTHER SELLER CONDUCT WILL CREATE AN EXPRESS WARRANTY BEYOND THE TERMS DESCRIBED HERE.

#### HOW LONG COVERAGE LASTS

The warranty on SOLOVELA, TYPE A, MATCH 60 & 80, PVM1, PVM2, BLADE and SERIES H, L & R lasts as long as the original purchaser owns the above referenced OCEAN product and can prove the origin of can prove the origin of purchase. This warranty terminates if the original purchaser sells or transfers the product.

#### WHAT OCEAN WILL DO

Obligation under this warranty is limited to repair, replacement, or credit for the defective product at the discretion of OCEAN

#### HOW TO GET SERVICE

Purchaser should return the defective product to the location where the purchase was made, along with a copy of the original sales receipt documenting the date of purchase and the OCEAN item number, as well as a description of the conditions in which the product was used and the alleged defect MUST accompany all warranty claims.

OCEAN shall have the right to inspect said product and Purchaser shall, if requested, return the defective product to OCEAN.  
OCEAN is not responsible for postage on the return of defective products. No return merchandise will be accepted without prior authorization.



H2



H3



H4



H5



H6



H7



H8



H9



*One piece made*



*Consistent wall thickness*

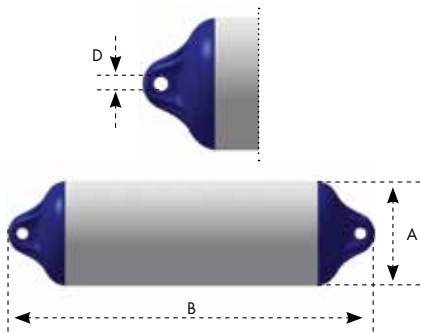

- Inflation pressure: 2.1lbs/0,15bar at 68°F/20°C
- Material : Plastisol PVC
- Production procces: Single procedure Rotational moulding

Suitable for



			Dimensions A x B (cm)	Eye-Diameter D (cm)	Volume per products (lt)
H2		71984	14 x 50	1,3	6,3
H3		71985	16 x 56	1,8	9,1
		72148			
H4		71986	19 x 64	1,8	14,5
H5		71987	22 x 64	2,2	18,6
		72137			
H6		71988	22 x 76	2,2	23,2
		72138			
H7		71989	28 x 76	2,4	35,1
H8		71990	22 x 104	2,2	33,8
		72139			
H9		71991	28 x 109	2,4	55,4

# SERIES L *standard duty*

## OCEAN Classic Fenders

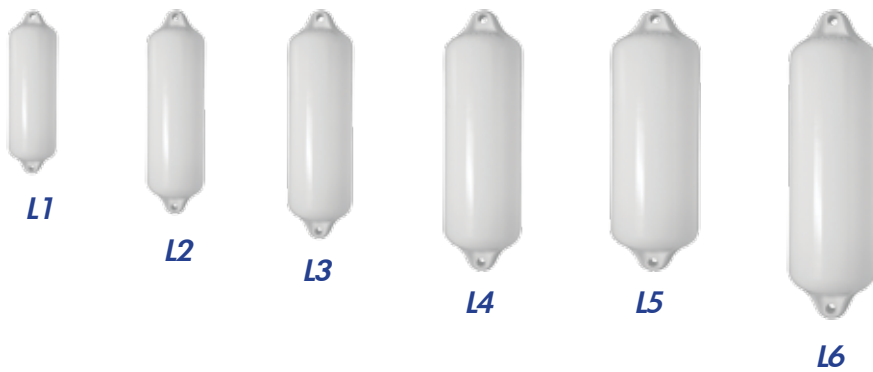

***One piece made***

			Dimensions A x B (cm)	Eye-Diameter D (cm)	Volume per products (lt)
L1		71977	12 x 40	1,3	3,6
L2		71978	14 x 50	1,3	6,3
L3		71979	16 x 56	1,8	9,1
L4		71980	19 x 64	1,8	14,5
L5		71981	22 x 64	2,2	18,6
L6		71982	22 x 76	2,2	23,2

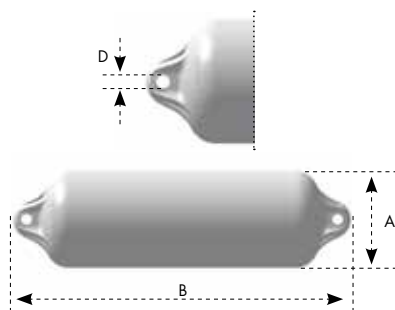

- Inflation pressure: 2.1lbs/0,15bar at 68°F/20°C
- Material : Plastisol PVC
- Production proces: Single procedure Rotational moulding

Suitable for





# SERIES RT *rope-through*

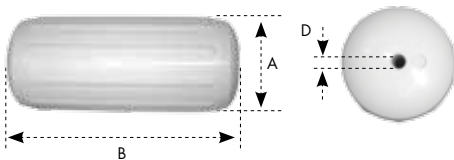
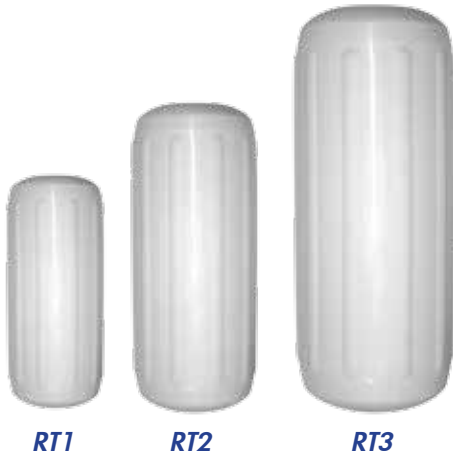

			Dimensions A x B (cm)	Hole-Diameter D (cm)	Volume per products (lt)
RT1		72107	16 x 39,5	1,6	7,7
RT2		72108	21,5 x 52	1,6	18,3
RT3		72109	26,5 x 68,5	1,6	36,6

- Inflation pressure: 2.1lbs/0,15bar at 68°F/20°C
- Material : Plastisol PVC
- Production proces: Single procedure Rotational moulding

Suitable for



## Fender Covers

- UV resistant fabric



Single



Double

		Dimensions (cm)	Ocean Fenders	Polyform Fenders	Thickness	Packing (pcs)
	49932	15x56cm	L3 & H3	F1	Single	2
	49351	23x56cm	L5 & H5	F2	Single	2
	49352	23x76cm	L6 & H6	F3	Single	2
	49353	23x104cm	H8	F4	Single	2
	49354	30x76cm	L7 & H7	F5	Single	2
	49355	30x107cm	H9	F6	Single	2
	49356	38x102cm	-	F7	Double	1
	49935	38x140cm	H10	F8	Double	1
	49936	51x127cm	-	F10	Double	1
	49937	61x140cm	-	F11	Double	1
	49938	81x190cm	-	F13	Double	1



# SERIES R

## OCEAN Classic Fenders

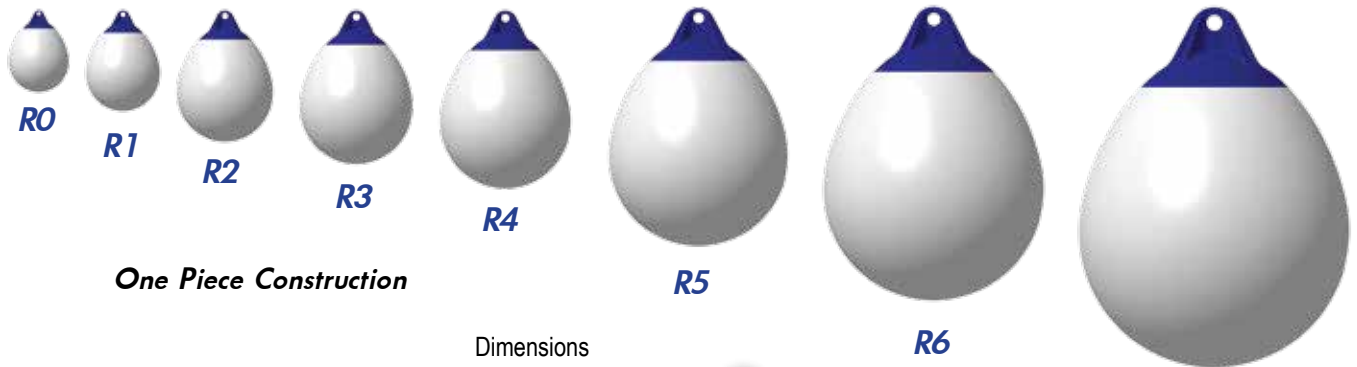

One Piece Construction

Dimensions

R0		71993		72001	22x30 cm
R1		71994		72002	28x38 cm
R2		71995		72003	38x50 cm
R3		71996		72004	44x58 cm
R4		71997		72005	52x68 cm
R5		71998		72006	68x90 cm
R6		71999		72007	88x112 cm
R7		72000		72008	100x138 cm

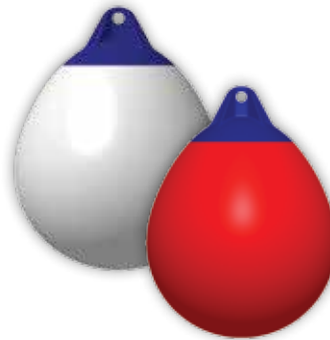

- Inflation pressure: 2.1lbs/0,15bar at 68°F/20°C
- Material : Plastisol PVC
- Production proces: Single procedure Rotational moulding

Suitable for

- UV resistant fabric

## Fender Covers

	Dimensions (cm)	Ocean Fenders	Polyform Fenders	Thickness	Packing (pcs)
	49933	20x29cm	R0	A0	Single 2
	49934	29x37cm	R1	A1	Single 2
	49358	39x49cm	R2	A2	Single 2
	49359	47x59cm	R3	A3	Single 2
	49360	55x71cm	R4	A4	Single 2
	49361	70x92cm	R5	A5	Single 2
	49362	86x118cm	R6	A6	Double 1
	49363	99x137cm	R7	A7	Double 1

Single



Double



# SERIES M

## OCEAN Mooring Buoys

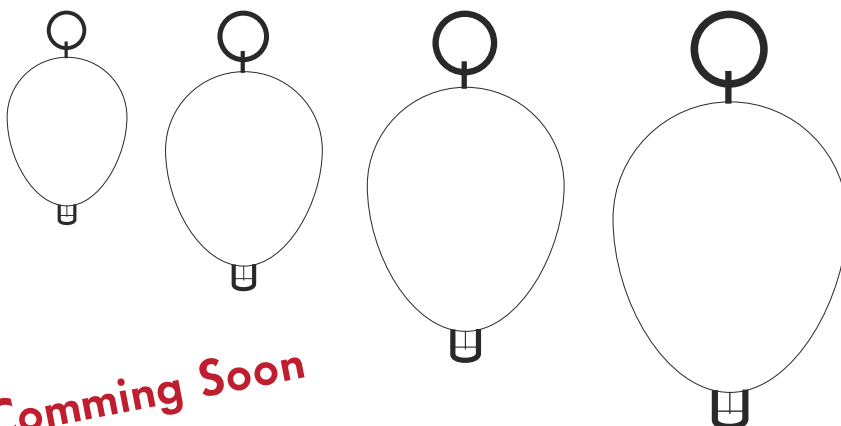

M0		72009	30x38,5 cm
M1		72010	40x52 cm
M2		72011	50x65 cm
M3		72012	60x78 cm

Comming Soon

## OCEAN Inflatable Fenders

The "Easystore Plus" Inflatable fenders are made of reinforced, abrasion resistant PVC material. They are light, simple to use and when deflated can be stowed in small lockers. They can be quickly inflated by using any standard or electric pump and easily mounted using the rope supplied. The "Easystore Plus" Inflatable fenders are available in various sizes and in light grey colour.

# MEGA YACHT FENDERS

NEW

## EASYSTORE PLUS

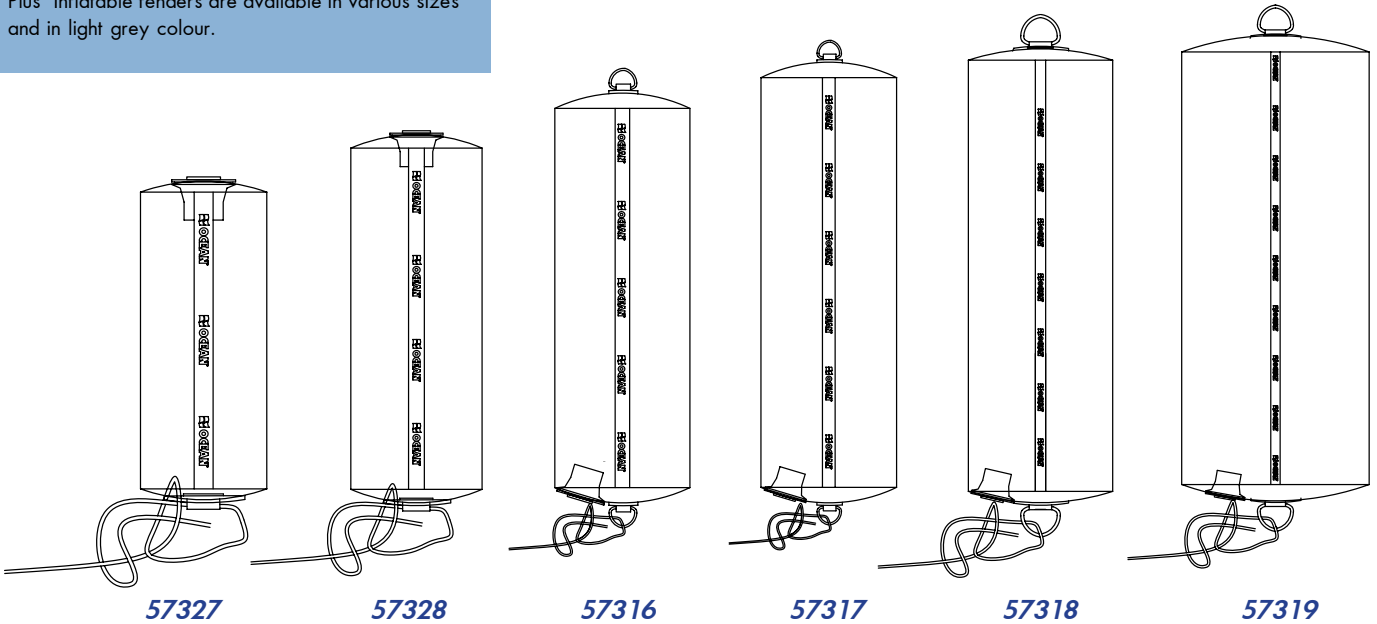

	Diameter (cm)	Length (cm)	D-ring	Rope
57327	20	50	-	3m
57328	25	70	-	3m
57316	28	85	2	3m
57317	32	104	2	3m
57318	42	132	2	5m
57319	60	150	2	5m

- Thickness: 0,9mm
- Material: PVC Body
- D-ring
- Rope: Ø 7mm
- Recommended inflation pressure: 2,4psi

Suitable for



# NEW MEGA YACHT FENDERS

## OCEAN Inflatable Fenders

### MAGNUS FENDER

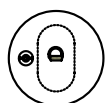
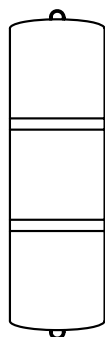

72159

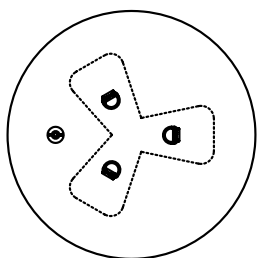
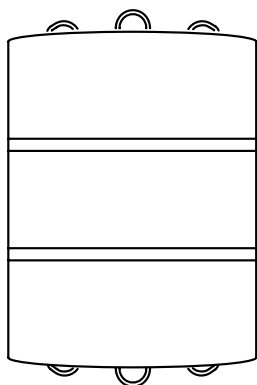

72162

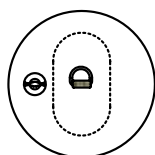
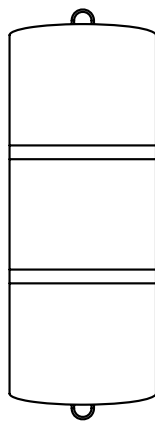

72160

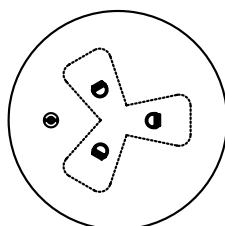
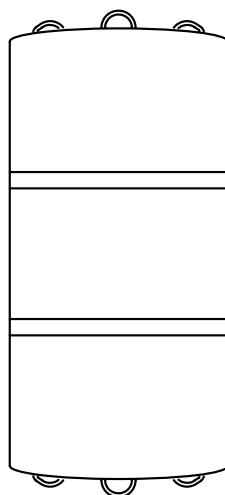

72161

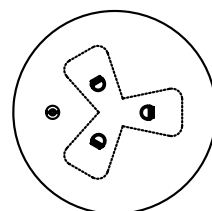
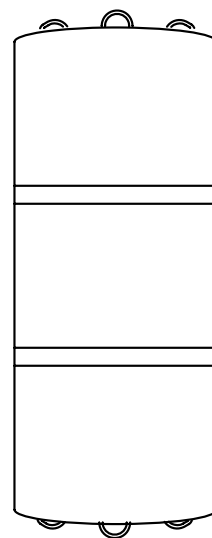

72163

	Diameter (cm)	Length (cm)	D-ring on top	D-ring on bottom
72159	42	132	1	1
72162	110	135	3	3
72160	65	160	1	1
72161	97	191	3	3
72163	90	210	3	3



- Thickness: 1.2mm
- Material: PVC Body
- D-ring
- Wrap around tape
- Recommended inflation pressure: 2,4psi



Suitable for



# SOLOVELA



Multipurpose fender, best in class shock absorption and life performance. It cannot deflate. **Tested under 12 tons per dm<sup>2</sup>**. Flexible integral skin foam technology. Always in place and ready to use, easy fitting on lifeline, no stowage required when sailing. **Can also be used as a step and as a backrest.** Steady with strong wind.

Supplied with a blu navy or sand UV resistant zip-on cover and a 3 m white polyester line. One through hole with nylon fiber reinforced bushes for easy and safe installation.

● 473215		● 197742		
L (mm)	H (mm)	W (mm)	▲ (ft)	⚖ (kg)
380	600	190	30-70	4,2



- Tested under 12 tons per dm<sup>2</sup>.
- Can also be used as a step and as a backrest.

Suitable for 

## Cover for SOLOVELA

Secured in place with adjustable cord and a spring clip. 100% soft polyester with exceptional UV resistance.

● 197782	● 197783
----------	----------



# TYPE A *clip-on fenders*

Best in class shock absorption and life performance. **The first and unique clip-on fenders**, flexible integral skin foam technology. Exceptional boat protection and durability, cannot deflate. Always in place and ready to use, no stowage required when sailing. **Can be used both horizontally and vertically**, steady with strong wind. One through hole with nylon fiber reinforced bushes for easy and safe installation.



A1	●	197747	●	197748
A2	●	197749	●	197750
A3	●	197751	●	197752
A4	●	197753	●	197754

Model	Ø (mm)	L (mm)	⊖ (kg)	⊖ (ft)	Ø GUARDRAILS (mm)
A1	160	380	1,5	20	20-26
A2	200	460	2,5	33	20-28
A3	230	530	3,8	43	25-30
A4	250	600	4,8	>43	25-30



- The first and unique clip-on fenders
- Can be used both horizontally and vertically

Suitable for



## OCEAN Solid fenders

# PVM1 universal

Best in class shock absorption and life performance. **The first and unique universal bow fender**, flexible integral skin foam technology. **Ideal for bow berthing, swim platform and dock fending.** It protects the bow from anchor swinging. Exceptional bow protection and durability, cannot deflate. Always in place, **it fits all bow shapes.** Two through holes with nylon fiber reinforced bushes for easy and safe installation.



● 472461 ● 472462

L (mm)	H (mm)	W (mm)	⊕ (kg)
600	250	170	3,2



Suitable for



- The first and unique universal bow fender
- Ideal for bow berthing, swim platform and dock fending
- It fits all bow shapes

# PVM2

Best in class shock absorption and life performance. Flexible integral skin foam technology. **Ideal for swim platforms applications.** Exceptional protection and durability, cannot deflate. PVM2 used for swim platform with thickness up to 15 cm and it is **designed for corner protection.** Through holes with nylon fiber reinforced bushes for easy and safe installation.

● 472463 ● 472464

L (mm)	H (mm)	W (mm)	⊕ (kg)
430	240	250	2,5

- Ideal for swim platforms applications
- It is designed for corner protection



Suitable for



# BLADE cruiser/racer

Best in class shock absorption and life performance. **The first and unique bow fender for 90° bow shape.** Flexible integral skin foam technology. Exceptional boat protection and durability, cannot deflate. Designed to stay fixed in place. One through hole with nylon fiber reinforced bushes for easy and safe installation.



● 197745 ● 197746

L (mm)	H (mm)	W (mm)	⊕ (kg)	MAX BOW SHAPE WIDTH (mm)
1040	160	120	2,7	70

- The first and unique bow fender for 90° stern shape.

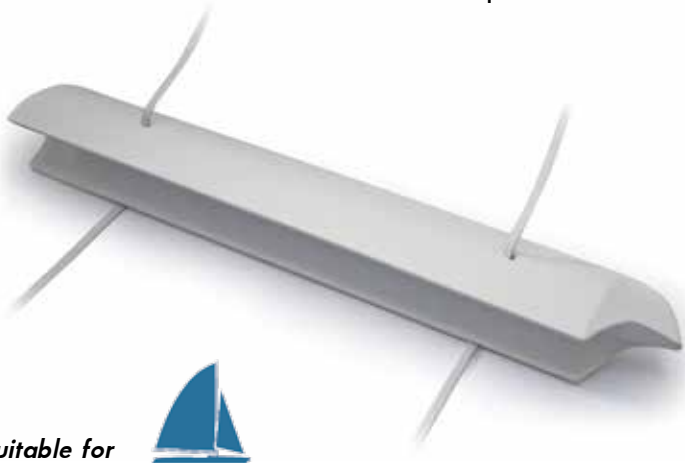

Suitable for



# MATCH 60

Best in class shock absorption and life performance. **The first and unique universal stern fender**, flexible integral skin foam technology. **Ideal for stern berthing**. It protects the stern from anchor swinging. Exceptional bow protection and durability, cannot deflate. Always in place, **it fits all stern shapes**. Two through holes with nylon fiber reinforced bushes for easy and safe installation.



● 421084	● 421110		
L (mm)	H (mm)	W (mm)	⊕ (kg)
600	320	250	4,2



- The first and unique universal stern fender
- Ideal for stern berthing
- It fits all stern shapes

Suitable for



# MATCH 80

Best in class shock absorption and life performance. **The first and unique stern fender for 90° stern shape**. Flexible integral skin foam technology. Exceptional boat protection and durability, cannot deflate. Designed to stay fixed in place. One through hole with nylon fiber reinforced bushes for easy and safe installation.



● 197744	● 197743		
L (mm)	H (mm)	W (mm)	⊕ (kg)
660	280	240	4,2



- The first and unique stern fender for 90° stern shape

Suitable for





**PATENT**

472465

**OCEAN Dock fenders**

**Lifetime Warranty**

472466

472465 Dock Fender, curved-ending, Navy blue

472466 Dock Fender, Navy blue

472467 Clip-on for Dock Fender, Set of 6 pcs

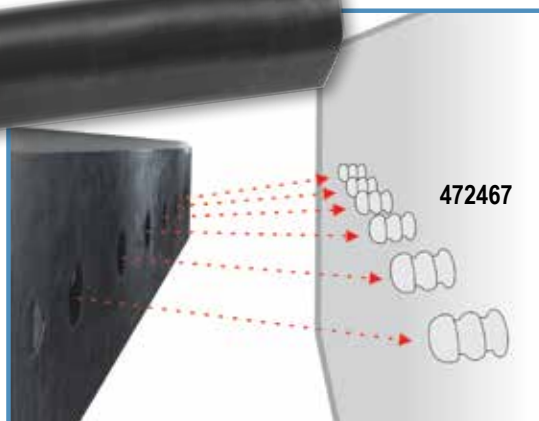

Length (mm)	Width (mm)	Height (mm)
1045	230	200

**OCEAN Sail Accessories**

**Clip-on LIFEBOUOY SUPPORT for rail**

Quick lifebuoy release system. Ideal for all standard lifebuoy rings and horse-shoe with 400 mm max circumference. Flexible integral skin foam technology.



● 197763

Rail Ø (mm)	L (mm)	H (mm)	W (mm)	⊕ (kg)
25-28	140	120	180	0,45



**Clip-on STANCHION cover**

Unique flexible stanchion cover. Provides ideal protection for all bow sails. Flexible integral skin foam technology. Easy to fit with 2 nylon clip included. Colour: White and Aluminum.



● 197757 ● 197758

L (mm)	H (mm)	W (mm)	⊕ (kg)
100	70	34	0,06

- Provides ideal protection for all bow sails
- Easy to fit with 2 nylon clip included

# SAIL DEFENDER *clip-on lifeline cover*

Unique flexible lifeline cover to fit all pulpit in line with the lifeline. Provides ideal protection for all bow sails. Flexible integral skin foam technology. Easy to fit with 5 nylon clips included. Colour: White and Aluminum.



● 197759 ● 197760

L (mm)	H (mm)	W (mm)	⊕ (kg)
320	70	45	0,21



- Provides ideal protection for all bow sails
- Easy to fit with 5 nylon clips included



# ALVEA *drinks Tray*

Unique and useful glass and bottle tray. Non slip material. Smart design to hold cups firmly even when empty. Flexible integral skin foam technology. Can be clipped on all guardrails, pulpit and stanchion. Colour: Navy Blue.



● 473084

L (mm)	W (mm)	H (mm)	⊕ (kg)
270	230	50	0,3





**“FENDING”, INNOVATION AND EXCELLENCE**

# Clip-on CAN HOLDER

**Perfect fit for glasses, bottles and cans**

An object holder for Mobile phones, eyeglasses, portable VHF and GPS, etc.

*A must have accessory*



- 470089
- 197761
- 197762

Ø GUARDRAILS (mm)	L (mm)	W (mm)	H (mm)	⊕ (kg)
22-26	130	90	100	0,25



**Unique Product - Supreme Quality**

**Flexible integral PU skin foam technology**

**Maximum Durability**

**Easy "clip-on" any guardrails**





Via Fontanelle 22,  
16012 Busalla (Ge), Italia  
Tel: +39 010 96801  
Fax: +39 010 9680150-159  
P.IVA & C.F: 02153990995  
[contact@oceanfenders.com](mailto:contact@oceanfenders.com)  
[www.oceanfenders.com](http://www.oceanfenders.com)